

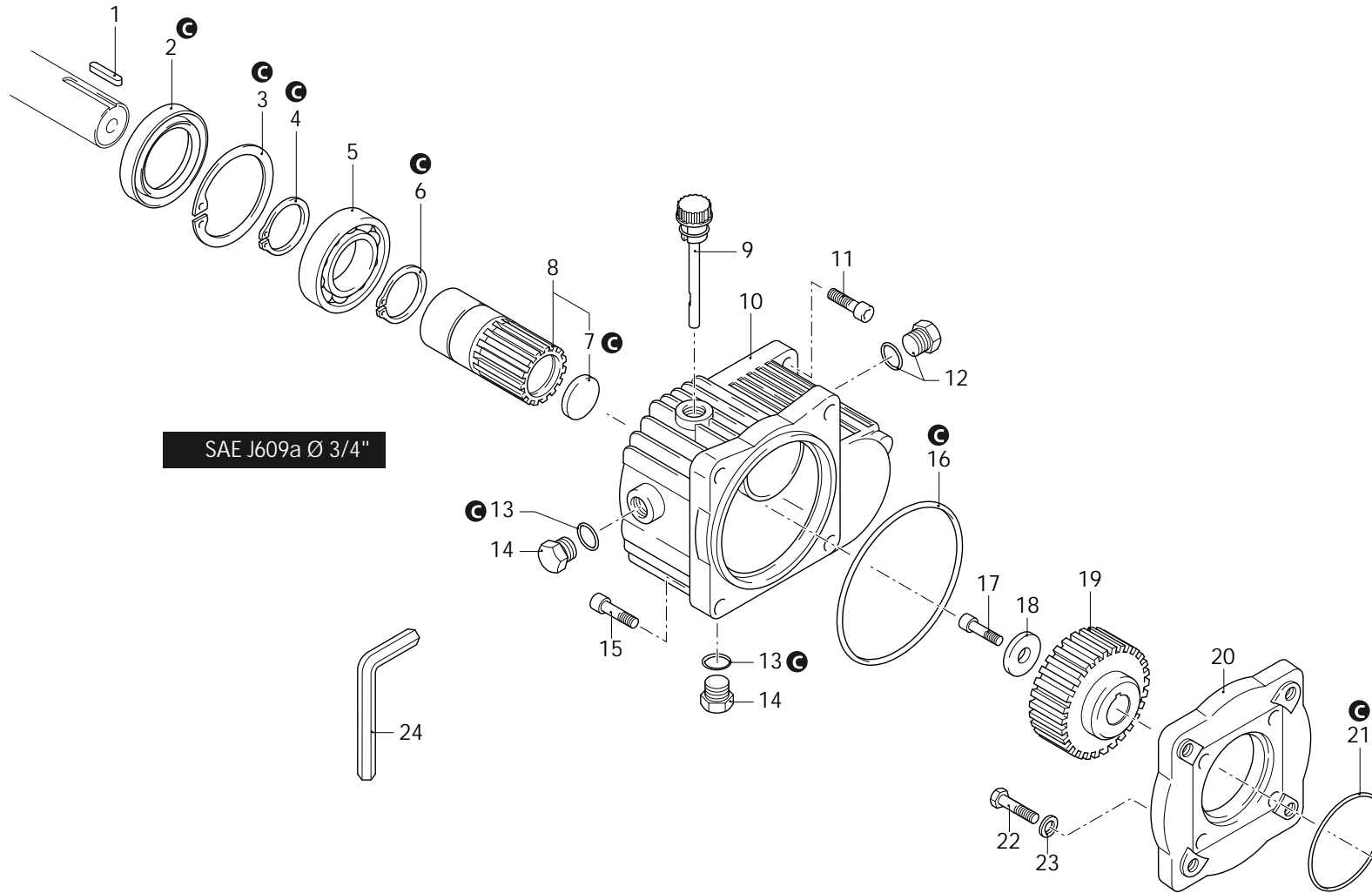

Gear Box
CR 3/4"

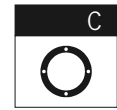



Gear Box CR 3/4"

P	Code	Description	Q	Note	Validity	P	Code	Description	Q	Note	Validity
1	881090	Key	1								
2	961800	Ring	1	seal							
3	961790	Ring	1	seeger Øi 68							
4	320240	Ring	1	seeger Øe 40							
5	961781	Bearing	1								
6	320240	Ring	1	seeger Øe 40							
7	1382530	Plug	1								
8	1322930	Pinion	1	Z=21							
9	1140370	Plug	1								
10	1320910	Box	1								
11	651000	Screw	4	TCEI 5/16" 24 UNF 1"							
12	1980290	Level gauge	1	3/8" G	C=8Nm						
13	740290	O-ring	2	Ø 14x1,78	Lubricate with grease Molykote PG54						
14	1980740	Plug	2	3/8" G brass	C=20Nm						
15	160671	Screw	4	TCEI M10x25	Screw with Loxeal 55-14 / C=24Nm						
16	1520590	O-ring	1	Ø 107,67x1,78							
17	880280	Screw	1	TCEI M6x18	Screw with Loxeal 55-14 / C=10Nm						
18	780230	Washer	1								
19	1320960	Gear	1	Z=47							
20	1320930	Flange	1								
21	640030	O-ring	1	Ø 59,99x2,62							
22	180432	Screw	4	TE M8x20	Screw with Loxeal 55-14 / C=24Nm						
22	390450	Screw	4	TE M8x30	Screw with Loxeal 55-14 / C=24Nm						
23	1260100	Washer	4								
24	1380630	Key	1								
C	2525	Oil seal kit	1								

Revision: 1

Oil type: ISO VG 220

Attachment:

Date: 17/01/2023

Oil quantity: 0,210 Kg

C= Tightening torque (Tolerance +0 ÷ -10%)

** = Not present for electric pump*