



Series 194
SXW

N

1450rpm

ø 24mm

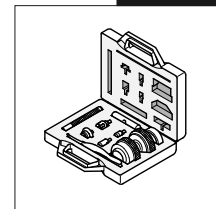
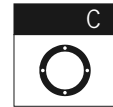
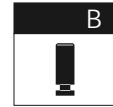
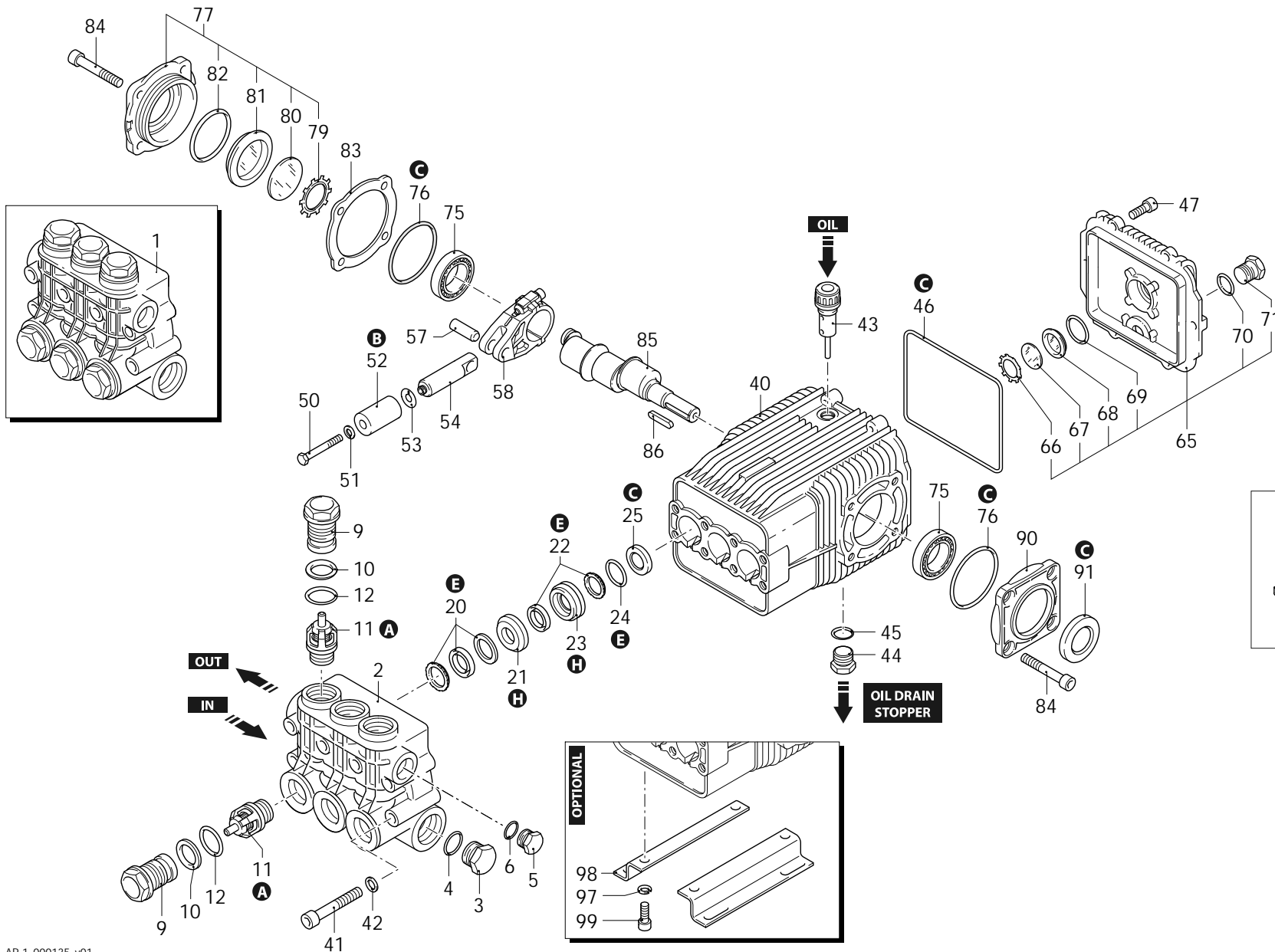

AR-1_000135_v01

30/11/2021



Series 194
SXW

N

1450rpm

ø 24mm

P	Code	Description	Q	Note	Validity	P	Code	Description	Q	Note	Validity
1	1949220	Head assembly	1	Ø 18		75	1140410	Bearing	2		
2	1942530	Head	1			76	1941380	O-ring	2	Ø 66,34x2,62	
3	820361	Plug	1	1/2" G brass	C=40Nm	77	1949011	Cover	1		
4	180101	O-ring	1	Ø 17,5x2	Lubricate with grease Molykote PG54	79	1941290	Ring	1		
5	1980740	Plug	1	3/8" G brass	C=20Nm	80	1941260	Plate	1		
6	740290	O-ring	1	Ø 14x1,78	Lubricate with grease Molykote PG54	81	1941270	Level gauge	1		
9	1940940	Plug	6			82	100410	O-ring	1	Ø 34,6x2,62	
10	1941070	Ring	6	anti-extrusion		83	1941390	Shim 0.05mm	1		
11	1949051	Complete valve	6			83	1941400	Shim 0.10mm	1		
12	880830	O-ring	6	Ø 15,54x2,62		83	1941410	Shim 0.19mm	1		
20	1942700	Gasket	3		Lubricate with grease Molykote PG54	83	1941420	Shim 0.25mm	1		
21	1942470	Piston guide	3	front Ø 18		84	850370	Screw	8	TCEI M8x16	C=24,5Nm
22	1942690	Water seal	3		Lubricate with grease Molykote PG54	85	1940970	Shaft	1	7 marked	
23	1942480	Piston guide	3	rear Ø 18		86	650250	Key	1		
24	820490	O-ring	3	Ø 34,65x1,78		90	1941240	Support	1		
25	1940560	Ring	3	seal		91	820680	Ring	1	seal	Screw with Loxeal 55-14 / C=10Nm
40	1941330	Pump body	1			97	200231	Washer	4		
41	1940260	Screw	8	TCEI M10x80	C=50Nm	98	1940370	Foot	2		
42	650530	Washer	8			99	1940380	Screw	4	TCEI 10x18	C=50Nm
43	1140370	Plug	1			A	2871	Valve kit	1		
44	1980740	Plug	1	3/8" G brass	C=20Nm	B	2872	Piston kit	1	Ø 18	
45	740290	O-ring	1	Ø 14x1,78	Lubricate with grease Molykote PG54	C	2873	Oil seal kit	1		
46	1940410	O-ring	1	Ø 132x3		E	2874	Water seal kit	1	Ø 18	
47	1200430	Screw	6	TCEI M6x16	Screw with Loxeal 55-14 / C=10Nm	H	42120	Piston guide kit	1	Ø 18	
50	1941640	Screw	3	TE M6x60	Screw with Loxeal 55-14 / C=7Nm	L	2248	Tools kit	1	Head maintenance	
51	1340600	Washer	3								
52	1941020	Piston	3	Ø 18							
53	1383190	Plate	3								
54	1940960	Piston	3	guide							
57	1940060	Pin	3								
58	1940051	Connecting-rod	3	aluminium	Lubricate with grease Molykote BR2 PLUS						
65	1949010	Cover	1	complete							
66	1260430	Ring	1								
67	1780690	Plate	1								
68	1260250	Level gauge	1								
69	1140450	O-ring	1	Ø 20,24x2,62	Lubricate with grease Molykote PG54						
70	1980740	Plug	1	3/8" G brass	C=20Nm						
71	740290	O-ring	1	Ø 14x1,78	Lubricate with grease Molykote PG54						

Revision: 1

Oil type: SAE 15W40

Attachment:

Date: 30/11/2021

Oil quantity: 0,870 Kg

C=Tightening torque (Tolerance +0 ÷ -10%)